

VOXXADAS[®]

ADVANCED DRIVER ASSISTANCE SYSTEMS

OWNER'S GUIDE

4K AI DASH CAM / ACADC5

REV: 0



Contents

1 Usage Caution.....	4
1.1 Warning.....	4
1.2 Maintenance Precautions	5
2 Product Introduction	5
2.1 Product Feature.....	5
2.2 Product Overview	7
2.3 Product Specification.....	8
2.4 Package Contents	9
3 AI Functions	10
3.1 Auto-Calibration	10
3.2 Lane Departure Warning.....	11
3.3 Forward Collision Warning	12
3.4 Virtual Bumper	12
3.5 Pedestrian Collision Warning.....	13
3.6 Stop & Go.....	13
3.7 Lane Changing Assistance	14
3.8 Rear Collision Warning.....	15
3.9 Vehicle Mode.....	16
4 Dash Cam Recording	16
4.1 Loop Recording	17
4.2 Emergency Recording	20
4.3 Parking Mode Recording (Optional).....	21
5 Playback Mode.....	21
6 Menu and Settings.....	23
6.1 Settings	23
6.2 AI Function Settings.....	25
6.3 Voice Command.....	27
7 Simple Troubleshooting.....	28
8 VOXX ADAS Mobile App.....	30
8.1 Setup	30
8.2 App Layout Overview	32
8.3 Download Video Files to Phone.....	33
8.4 View, Edit, and Share Downloaded Videos.....	34

USE CAUTION

1 Usage Caution

1.1 Warning

1. The dangerous driving alerts issued by the active safety AI device are only voice alerts, which cannot replace the driver's driving decision and operation.
2. The dangerous driving alerts issued by the active safety AI device are developed based on computer vision and deep learning technology, which cannot guarantee 100% recognition accuracy. For example, under different road conditions and weather conditions, the accuracy rate of obstacle recognition is different.
3. This device is intended to enhance the situational awareness when used properly. If used improperly, you could be distracted by the display and cause an accident resulting in death or serious injury. DO NOT attempt access the information stored on in the device or change the device settings whilst driving. The device should only be operated when your vehicle is stationary, and you are parked in a safe place in accordance with local laws. Always maintain awareness of your surroundings and do not stare at the display or be distracted by the display. Focusing on the display could cause you to miss obstacles or hazards. Use the device at your own risk.
4. When installing the device in a vehicle, do not place the device where it will obstruct the driver's view of the road or interfere with vehicle operating controls, such as the steering wheel, foot pedals, or gear levers. Do not place unsecured on the dashboard of vehicle. Do not place the device in front of or over any airbag.
5. Video playback upon devices with display which are visible to the driver, is prohibited or restricted in some countries or States. Please comply with these laws.

1.2 Maintenance Precautions

1. Please keep the device dry. Do not let the device and cable stay in humid environment, or operate the device with wet hands, so as to avoid shorting the device.
2. Do not subject the device to strong impact or vibration to prevent the product from malfunctioning.
3. Do not expose the device and power supply under excessive high or too low temperature, as this may cause the product to malfunction.
4. Do not use power and data cables other than those approved or supplied by the manufacturer.

2 Product Introduction

2.1 Product Feature

1. High-definition recording, to capture every subtle detail of the driving process.
2. Wide Dynamic Recognition (WDR): Clearly capture details in both highlights and shadows, even in extremely bright and dark contrasts.
3. Super Night-Vision Mode: Capture clear images even in the dark night.
4. Advanced Driving Assistance System (ADAS): Sensing the vehicle's surrounding environment, real-time voice reminder of safe driving, forward collision warning, front car start, lane departure, and pedestrian collision.
5. Lane Change Assistance (LCA): Level 1 Monitors the driver's blind spot behind the vehicle; Level 2 Warns the driver when another vehicle poses a danger to the vehicle's lane change.
6. Rear Collision Warning (RCW): Real-time monitor the rear of the car, and issue a warning message when the rear collision may occur, always ensuring the rear safety for the user.

PRODUCT INTRODUCTION

7. Equipped with a 3-axis accelerometer to accurately detect vehicle movement or impact. In the case of emergency braking and collisions, the crash video is stored separately in Emergency Recording file.
8. Multi-camera support: Can be connected to front and rear cameras for complete security protection.
9. Wide Angle: Wide FOV enables camera to easily capture multiple lanes and reduce shooting blind spots.
10. Simultaneous Start: the camera will automatically start recording after the vehicle is started, and the camera will automatically shut off after the engine is turned off.
11. Parking Mode Recording: Records video if car is subjected to a collision when the engine is off (requires hardware kit to be connected).

PRODUCT INTRODUCTION

2.2 Product Overview

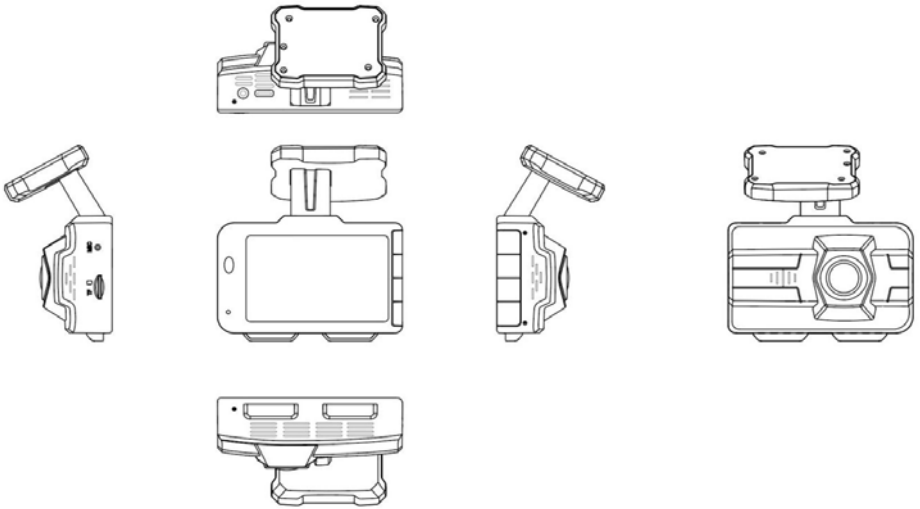

Front Camera

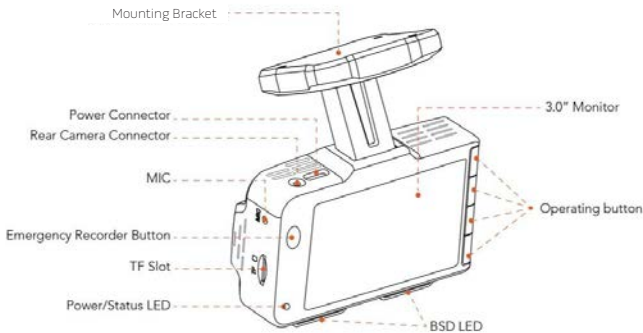

Rear Camera

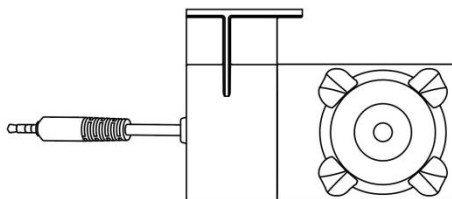

PRODUCT INTRODUCTION

2.3 Product Specification

Item	Description
GPS	Support
WiFi	Support
Screen	3.0"
Built-in G-sensor	Impact detection
Memory Card	External Memory Card (32 to 512GB Card in FAT32, UHS-III/ A1)
Angle / Aperture	Front Camera: F1.75, FOV 140° Rear Camera: F1.8, FOV 140°
Recording Resolution	FALCON SE4K: 4K@30fps + 1080p@30fps
Recording Format	MP4
Voice Command	Optional

PRODUCT INTRODUCTION

2.4 Package Contents

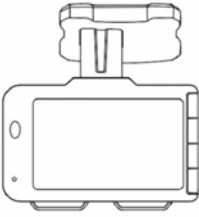

AI Dash Cam

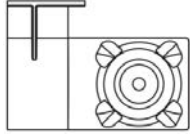

Rear Camera

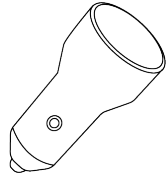

Car Power Adapter

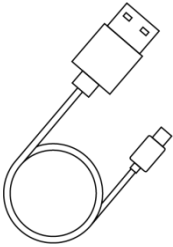

Type-C Power Cable

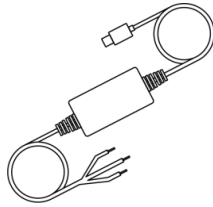

Hardwire Kit



Quick Start Guide



User Manual
(Digital)



Panel Pry Tool



64G TF Card

AI FUNCTIONS

3 AI Functions

3.1 Auto-Calibration

Upon the initial activation of the AI Dash Cam, an automatic calibration process for the AI algorithms will commence. The calibration duration may vary between 1 to 10 minutes, depending on the scene conditions captured. To expedite the calibration process, consider the following recommendations:

1. Drive on a road with a straight, level trajectory and clear lane markings.
2. Maintain a speed greater than 13 mph.
3. Choose routes with lower traffic density.
4. Minimize unnecessary lane changes.

After the calibration, the calibration icons on the status bar will be checked.

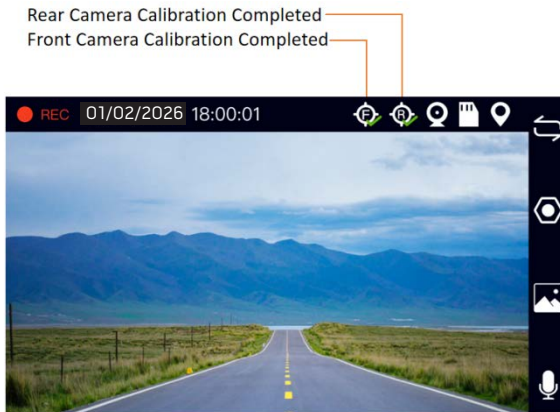

3.2 Lane Departure Warning

When current Vehicle speed > 40mph(60km/h) and the lane-center-driving vehicle state is changing to across the lane, the AI system will issue related sound alert to driver and display alert icon on the dash cam screen.

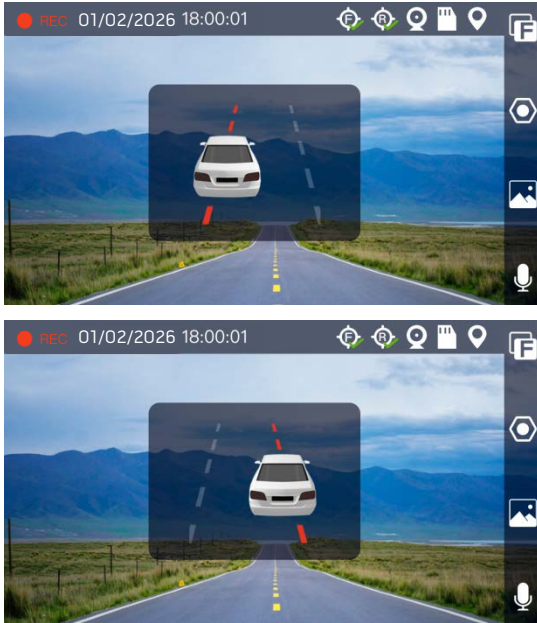

Lane Departure Warning

Note: Normal lane changing will also trigger this warning, this alarm can be turned off in the AI function settings.

AI FUNCTIONS

3.3 Forward Collision Warning

When current Vehicle speed $> 20\text{mph}(30\text{km/h})$ and the Time to Collision (TTC) between the vehicle and the vehicle ahead is less than 2.7s , the AI system will issue related sound alert to driver and display alert icon on the dash cam screen.



Forward Collision Warning

3.4 Virtual Bumper

When the distance between the vehicle and the vehicle ahead / Current vehicle speed $< 0.7\text{s}$, and $20\text{mph} >$ Current vehicle speed $> 0.6\text{mph}$, the AI system will issue related sound alert to driver and display alert icon on the dash cam screen. This function can be turned off in the AI Function settings, and the trigger sensitivity (high, medium, low) can also be modified.



Virtual Bumper

3.5 Pedestrian Collision Warning

When the distance between the vehicle and the pedestrian ahead / Current vehicle speed < 1.2s, and 40mph > Current vehicle speed > 0.6mph, the AI system will issue related sound alert to driver and display alert icon on the dash cam screen, This function can be turned off in the AI Function settings, and the trigger sensitivity (high, medium, low) can also be modified.



Pedestrian Collision Warning

3.6 Stop & Go

When the vehicle stops for more than 5s and the vehicle ahead (within 20 ft distance) continues to driving away for more than 1s, the AI system will issue related sound alert to driver and display alert icon on the dash cam screen. This function can be turned off in the AI Function settings, and the trigger sensitivity (high, medium, low) can also be modified.



Stop & Go

AI FUNCTIONS

3.7 Lane Changing Assistance

Level 1 Alert: If the velocity of vehicle $> 6\text{mph}(10\text{km/h})$, while another vehicle (within 23ft distance) is approaching from the rear-side lane, the AI alert will be triggered.

1. The LED indicator light will be solid on to remind the driver. The faster the speed, the farther the alarm can be triggered, up to 41ft.
2. When there is a car on your left rear, the orange LED on the left will be on, and when there is a car on your right rear, the green LED on the right will be on.



Level 2 Alert: If the velocity of vehicle $> 20\text{mph}(30\text{km/h})$ with its outer edge of wheel less than 0.32ft from the lane line, another vehicle (within 23ft distance) is approaching from the rear-side lane at the same time, the AI alert will be triggered.

1. The related LED indicator light will be solid on;
2. The sound alert will be issued every 3s;
3. The alert Icon (side-view mirror) will display on the dash cam screen. The faster the speed, the farther the alarm can be triggered, up to 41ft.



Lane Changing Assistance

Note: This Alarm will be triggered by an overtaking from the rear car even when you have no intention to change lanes.

3.8 Rear Collision Warning

If the on coming vehicle $> 20\text{mph}$, the Time to Collision (TTC) between the vehicle and the vehicle behind is less than 2,7s, the AI system will issue related sound alert to driver and display alert icon on the dash cam screen. This function can be turned off in the AI Function settings, and the trigger sensitivity (high, medium, low) can also be modified.



Rear Collision Warning

AI FUNCTIONS

3.9 Vehicle Mode

To ensure that Lane Changing Assistance and Rear Collision Warning work correctly in a (pick-up) truck, you can set the vehicle mode to either Sedan or Truck mode as required. **(Setting path: ADAS function-Vehicle mode)**

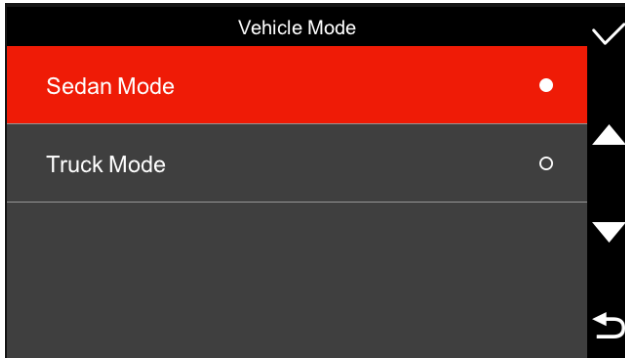

4 Dash Cam Recording

The screen displays  means the Memory card is normal.

The screen displays  means the Memory card is in failure.

The screen displays  means no Memory card is inserted.

DASH CAM RECORDING

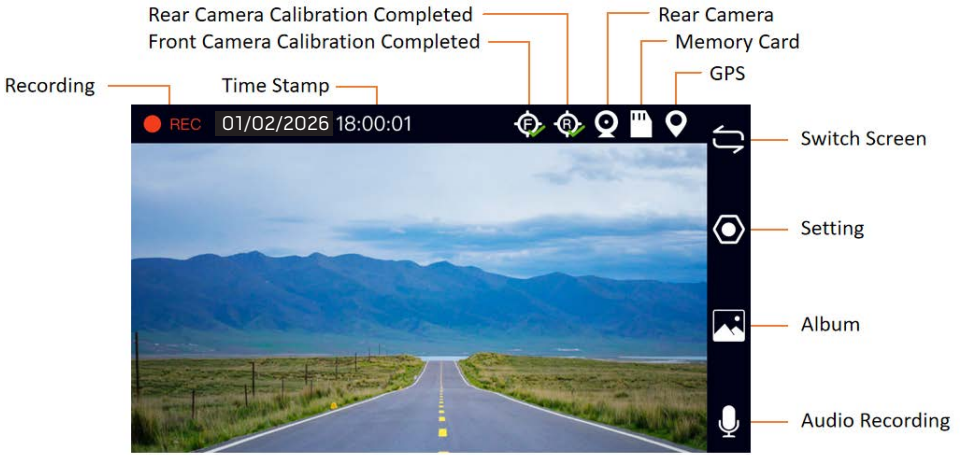

Interface Description

Time stamp is default on, able to turn off from [⚙️]-[Video Settings]-[Time stamp]

Front camera default as 4K@30fps(4K version), able to set as 4K@30fps or 2K@30fps or 1080P@30fps, [⚙️]-[Video Settings]-[Video resolution], Rear camera default as 1080P.

GPS Position:

Positioned: screen displays 📍, Non-positioned: screen display 📴.

4.1 Loop Recording

After the vehicle is started, the dash cam automatically turns on and starts recording. After the vehicle is turned off, the recording will stop automatically.

Note: REC red light flashing means the dash cam is recording. REC blue light on means the dash cam isn't recording.

DASH CAM RECORDING

Screen View Switching

Press the first button on the right to switch screens. The order of switching screens is as follows:

1. Traffic Visualization Interface (default).



2. Front camera view.
3. Rear camera view.
4. All view.



The Traffic Visualization Interface will show the real-time traffic environment. The left side of the screen shows the vehicles and pedestrians ahead, while the right side shows the speed of the vehicles moving.

DASH CAM RECORDING



When the device detects an object of interest in front of or behind the vehicle, the corresponding object and distance are displayed on the right side of the traffic visualization interface.

Audio Recording

System is default off, but able to turn on by switching  .

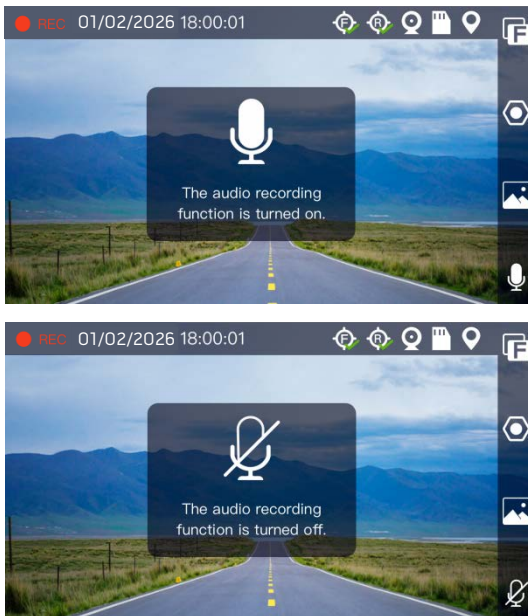

Audio recording switch

DASH CAM RECORDING

4.2 Emergency Recording

Emergency recording starts working under 2 conditions as below:

1. Impact detected (G-Sensor)

- If the dash cam detect an impact while loop recording, it will start emergency recording.
- If G-Sensor sensitivity is set as [high sensitivity], even slight impact would be detected.

2. Manual emergency recording

- Pushing the emergency button can start emergency recording while under the loop recording mode.

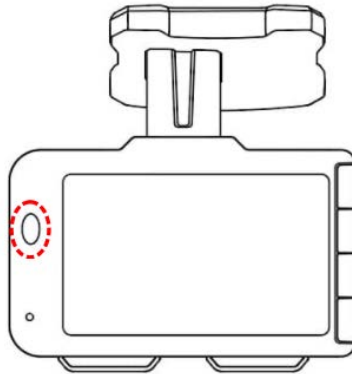

Emergency Recording Button

- Pushing the emergency button can also start emergency recording.

Note: Emergency videos will record a total of 20 seconds - 5 seconds prior to the trigger and 15 seconds afterward.



Emergency recording

4.3 Parking Mode Recording

After the Parking Mode Recording feature is activated, if the car is subjected to a collision or impact when the engine is off, it will power on and record an Event video for 20 seconds before shutting down.

Note: Parking mode requires hardwire kit to be connected.

5 Playback Mode

Pushing [📷] can enter the playback mode, and select ▲ or ▼ to choose the file type: Loop / Emergency / Parking, and select ✓ to enter and review.

1. 3 types of recording file: loop, emergency and parking.

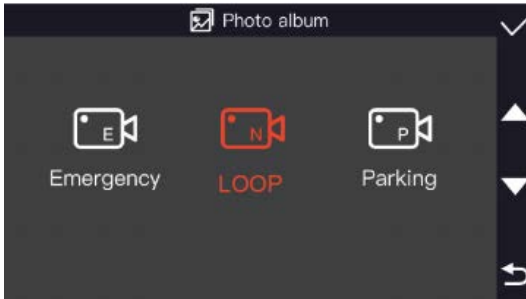

Types of recording file

2. Each recording type has 2 channel file: Front view and Rear view.

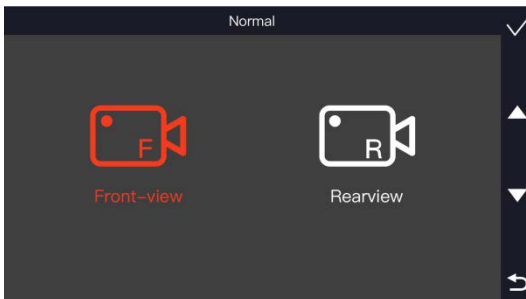

Types of channel file

PLAYBACK MODE

3. Once the storage capacity is reached, the oldest files within the Loop and Parking folders will be overwritten by new files. However, files within the Emergency folder will not be subject to loop replacement.
4. The playback progress adopts the forward timing method, and the file duration remains unchanged.

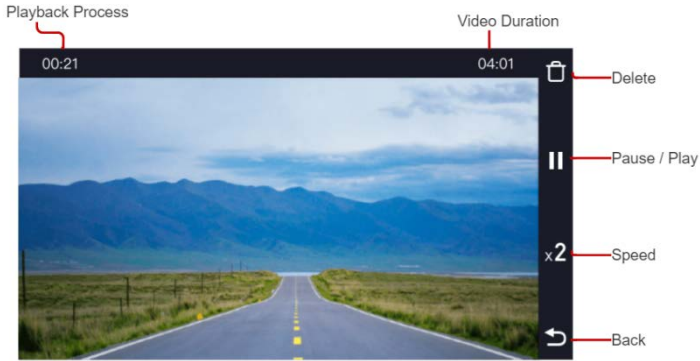

Video playback interface

5. Push [x1] to change the speed by 1X, 2X, 4X, 8X on a loop.

6 Menu and Settings

6.1 Settings

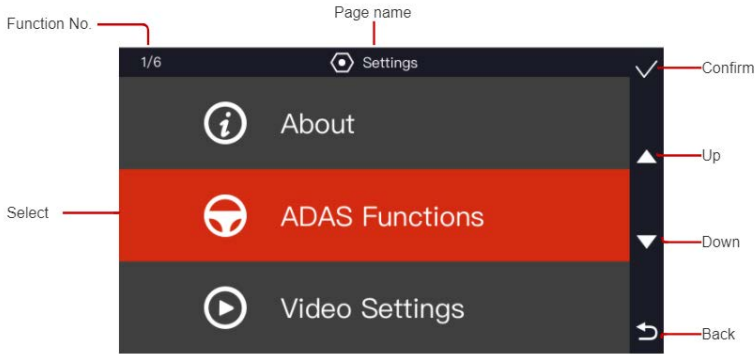

Operating Instructions

1. Video Settings

- 1) Recording resolution, recording duration time, Time stamp are settable.
- 2) Collision sensitivity setting: G-sensor support impact motion. When detect a impact, the dash cam can start emergency recording with 2 cameras.
- 3) Parking Mode: default as turn off. Able to turn on by working with extra Hardwire Kit.

2. Format the Memory card

The memory card may need to be formatted in the following situations.

- 1) If the dash cam can't work properly after changing a new memory card, please select [Format the memory card].

MENU AND SETTINGS

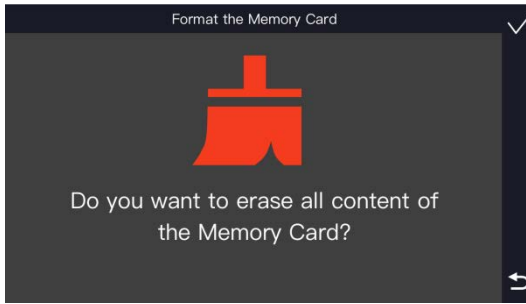

Format Confirmation

ACADC5 Functions

- 2) When the Memory card isn't FAT32, the screen will display as below, please change a new memory card FAT32.



Formatting Requests

3. Factory Default Settings

- 1) Factory Default Settings is an option that restores all settings of the AI Dash Cam to factory settings,
- 2) The screen will display as below:



Reset Confirmation

MENU AND SETTINGS

Select [✓], all settings will get back to the factory default, then back to [Setting] Page.

Select [↶], No change, then back to [Settings] Page.



Resetting progress

4. About

Product information and system version number, the screen displays as below:

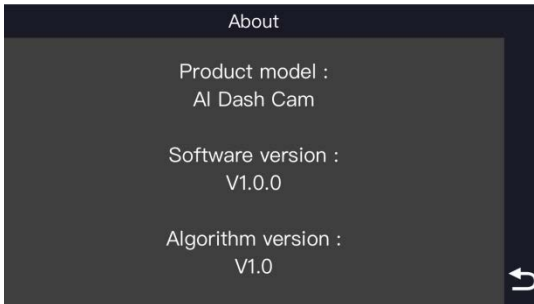

MENU AND SETTINGS

6.2 AI Function Settings

7 Functions: Lane Departure warning, Forward Collision warning, Pedestrian Collision Warning, Stop & Go, Virtual Bumper, Rear Collision Warning, Lane Change Assistance. These AI functions are turned on by default and their activate speed and sensitivity can be adjusted.

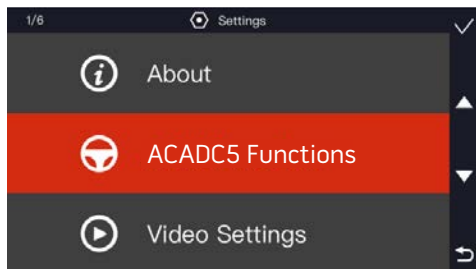

AI Function Setting List

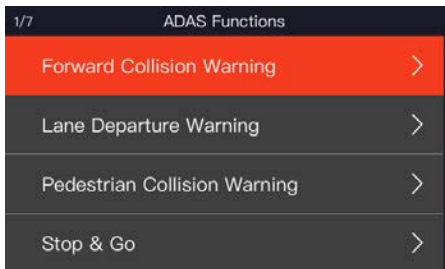

AI Function Selection



AI Function Settings

6.3 Voice Command

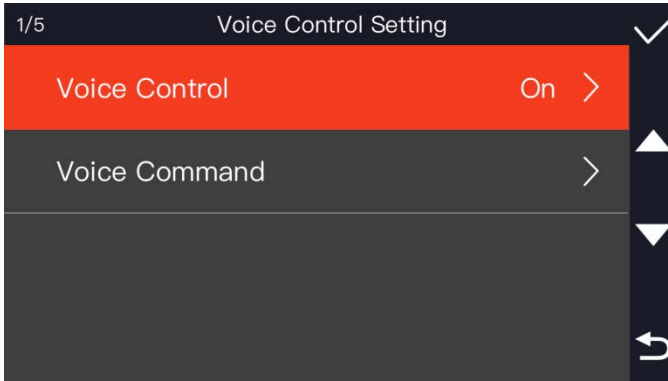

In "Settings - Advanced Settings - Voice Control Setting," you can enable or disable the Voice Control feature. Under Voice Commands, you'll find a list of specific voice instructions that the system can recognize.

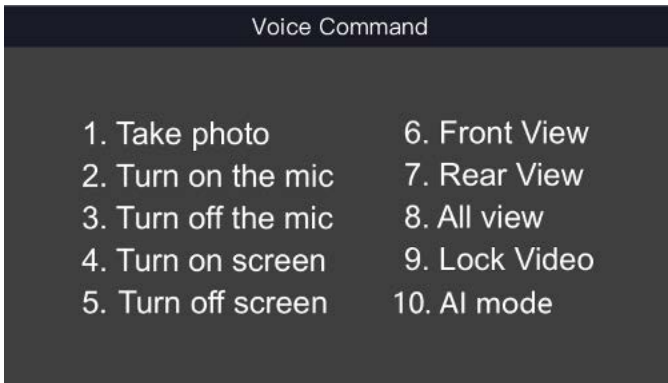

1. Take photo: The AI Dash Cam will capture a real-time photo.
2. Turn on the mic: Activate audio recording for video recording. Playback videos will include audio.
3. Turn off the mic: Deactivate sound recording for video recording. Playback videos will be silent.
4. Turn on screen: The AI Dash Cam will illuminate the screen backlight.
5. Turn off screen: The AI Dash Cam will dim the screen backlight.

TROUBLESHOOTING

6. Front View: The AI Dash Cam's screen will display the footage captured by the front camera.
7. Rear View: The AI Dash Cam's screen will display the footage captured by the rear camera.
8. All View: The AI Dash Cam will simultaneously display footage from both the front and rear cameras.
9. Lock Video: The AI Dash Cam will record a 20-second event video and lock it for safekeeping.

7 Simple Troubleshooting

Trouble	Solution
The recording is disabled	Please use a FAT32, read / write speed \geq UHS-III memory card.
The loop recording is disabled	Please check the space of memory card is enough for recording. Please format the memory card if not enough space.
The recording is blurry	Clean windshield and camera lens.
The recording has no audio	Please make sure you turn on the audio.
The dash cam is over temperature	When the dash cam is working at 4K / 2K, it's normal to get a little hot around the dash cam and Memory card port.
Recording files on the memory card can't display on the computer	Please change a new video player to display. If still unworkable, maybe the memory card get damaged, please try to format it or change a new one.
Others	If troubles above still can't be solved, please restore all settings to the factory settings or contact technical support.

FCC Regulatory Conformance

This device complies with Part 15 of the FCC Rules. Operation is subject to the following two conditions:

1. This device may not cause harmful interference.
2. This device must accept any interference received, including interference that may cause undesired operation.

NOTE: This equipment has been tested and found to comply with the limits for a **Class B** digital device, pursuant to part 15 of the FCC Rules. These limits are designed to provide reasonable protection against harmful interference in a residential installation.

This equipment generates uses and can radiate radio frequency energy and, if not installed and used in accordance with the instructions, may cause harmful interference to radio communications. However, there is no guarantee that interference will not occur in a particular installation. If this equipment does cause harmful interference to radio or television reception, which can be determined by turning the equipment off and on, the user is encouraged to try to correct the interference by one or more of the following measures:

- Reorient or relocate the receiving antenna.
- Increase the separation between the equipment and receiver.
- Connect the equipment into an outlet on a circuit different from that to which the receiver is connected.
- Consult the dealer or an experienced radio/TV technician for help

NOTE: The manufacturer is not responsible for any radio or TV interference caused by unauthorized modifications to this equipment. Such modifications could void the user's authority to operate the equipment.

This equipment complies with FCC radiation exposure limits set forth for an uncontrolled environment. This equipment should be installed and operated with minimum distance of 8 inches (20cm) between the radiator and your body. This transmitter must not be co-located or operated in conjunction with any other antenna or transmitter.

VOXX ADAS MOBILE APP

8 VOXX ADAS Mobile App

8.1 Setup

Scan the QR code or search “VOXX ADAS” in the App Store to locate and download the VOXX ADAS Mobile App.



Before opening the app, make sure the camera is powered ON and the “Wi-Fi” logo is displayed in the top right corner of the screen.

Camera

Open the module app and click the “Add Camera” button in the center of the screen.

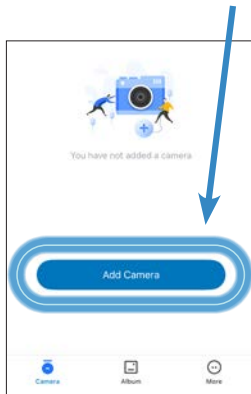

Some phones may request to use your location. Choose your preference for sharing your location.

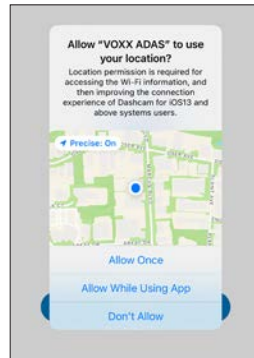

Wi-Fi

The app will guide you through the setup process.

Again, make sure the camera is installed and powered ON before continuing with Wi-Fi Setup.



VOXX ADAS MOBILE APP

Press the “Connect to Wi-Fi” button to access the phone’s Wi-Fi settings menu.

Locate and connect to the available Wi-Fi network labeled “AI_CAM_XXXX”. Note each camera will have a unique Wi-Fi name. This can be configured once setup is complete.



Enter the Wi-Fi password to complete the connection.

The default password is “12345678”. This can be changed once setup is complete.



Once the Wi-Fi connection is established, return to the VOXX ADAS Mobile App.

The app will ask to confirm the access to local networks. This is required to use the mobile app. Choose “Allow” to finalize the Wi-Fi setup.



VOXX ADAS MOBILE APP

The camera is now configured and connected to the mobile app. Click the “Access Camera” button to connect to the camera.

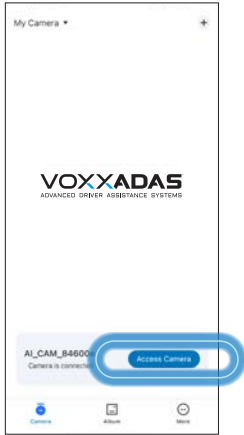

The app will display the live camera image at the top of the app screen. You can now view all stored video files and configure the camera using the mobile app.

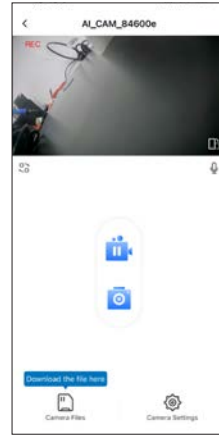

8.2 App Layout Overview

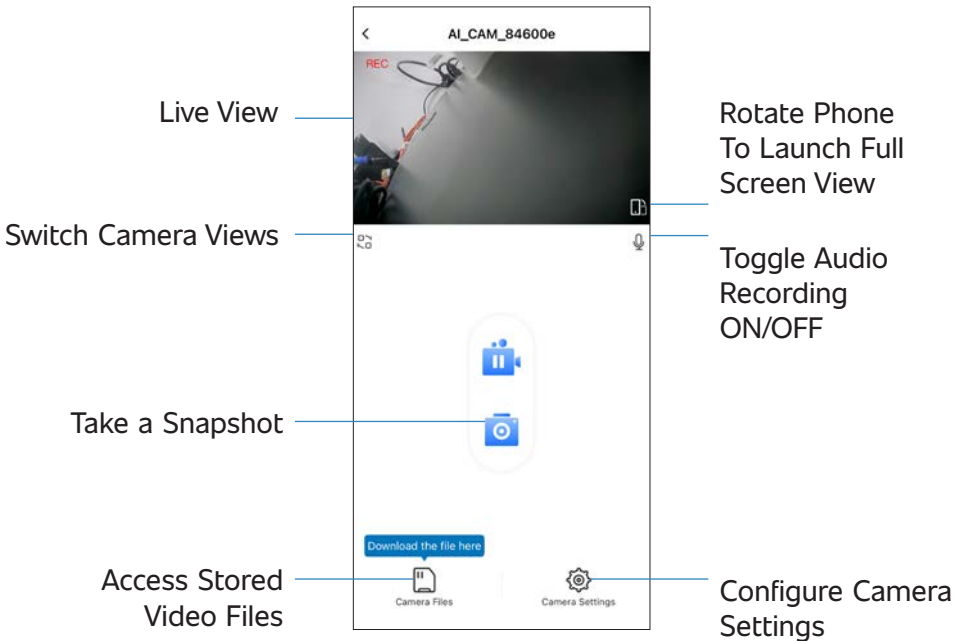

8.3 To Download Video Files to Phone

1. Make Wi-Fi connection to camera
2. Click “Camera Files” at the bottom left of the app screen.
3. Select the type of video file you would like to download

Loop – Continues video recording files.

Snapshot – Still Images taken and stored on SD card.

Event – Video files locked to SD card due to a G-Sensor event like a crash.

Parking – Video files recorded while in parking Mode.

There is 1 file for the front camera and another unique file for the rear camera. Be sure to download both files if needed.

4. To download files, click the “Select” option at the top right and then choose each file to be downloaded. Then click “Download” at the bottom right.

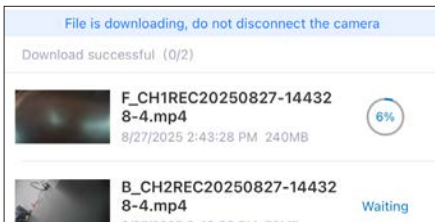

It is recommended to remain on the download page until the downloads are completed.

VOXX ADAS MOBILE APP

8.4 View, Edit, and Share Downloaded Videos

1. Downloaded videos provide detailed information like GPS location and speed. To view downloaded views, launch the VOXX ADAS Mobile App and choose "Album" at the bottom of the home screen.
2. Select the file to be viewed.

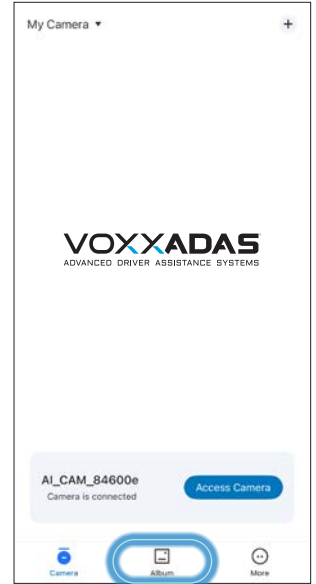

The file viewer will allow access to view, share, edit, or save a file to the phone's photo gallery.

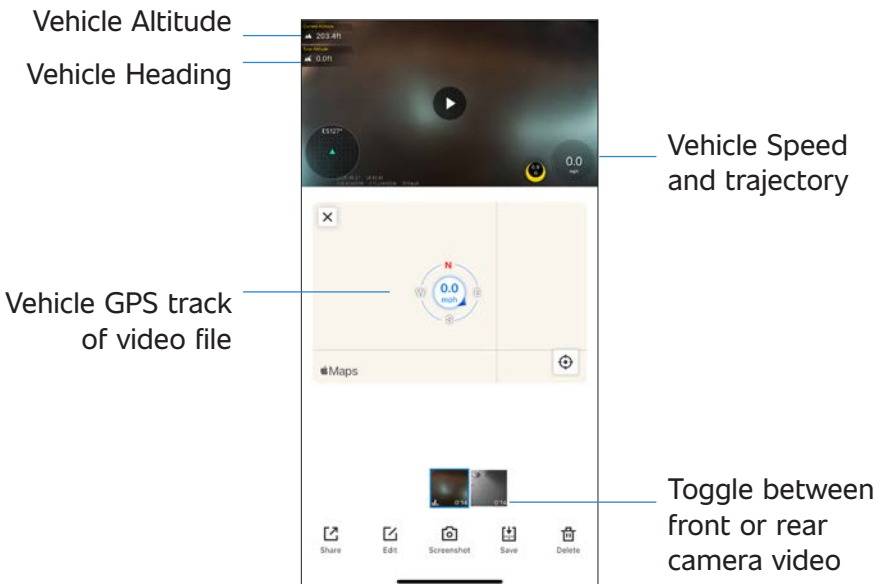

1 YEAR LIMITED WARRANTY

VOXX Electronics Corporation, a wholly-owned subsidiary of Gentex Corporation, warrants to the original purchaser of this product that should this product or any part there of, under normal use and conditions, be proven defective in material or workmanship within 12 months from the date of original purchase, such defect(s) will be repaired or replaced with new or reconditioned product,(at the Company's option) without charge for parts or repair labor. A transmitter for a vehicle security or remote start system is warranted for 12 months from the date of original purchase.

To obtain repair or replacement within the terms of this Warranty, the product is to be delivered with proof of warranty coverage (e.g. dated bill of sale), authorization number, specification of defect(s), transportation prepaid, to an approved warranty station. This warranty is not transferable.

This Warranty does not cover damage to the vehicle's electrical system or costs incurred for the installation, removal or re-installation of the product. This Warranty does not cover batteries, broken LCD transmitter display screens, nor apply to any product or part there-of which, in the opinion of the Company, has suffered or been damaged through alteration, improper installation, mishandling, misuse, abuse, neglect, accident, or by removal or defacement of the factory serial number/bar code label(s).

This Warranty is in lieu of all other express warranties or liabilities ANY IMPLIED WARRANTIES, INCLUDING ANY IMPLIED WARRANTY OF MERCHANTABILITY, SHALL BE LIMITED TO THE DURATION OF THIS WRITTEN WARRANTY. ANY ACTION FOR BREACH OF ANY WARRANTY HEREUNDER INCLUDING ANY IMPLIED WARRANTY OF MERCHANTABILITY MUST BE BROUGHT WITHIN A PERIOD OF 24 MONTHS FROM DATE OF ORIGINAL PURCHASE. IN NO CASE SHALL THE COMPANY BE LIABLE FOR ANY CONSEQUENTIAL OR INCIDENTAL DAMAGES FOR BREACH OF THIS OR ANY OTHER WARRANTY.

No person or representative is authorized to assume for the Company any liability other than expressed herein in connection with the sale of this product.

The company does not warrant that this product cannot be compromised or circumvented. THE EXTENT OF THE COMPANY'S LIABILITY UNDER THIS WARRANTY IS LIMITED TO THE REPAIR OR REPLACEMENT PROVIDED ABOVE AND, IN NO EVENT, SHALL THE COMPANY'S LIABILITY EXCEED THE PURCHASE PRICE PAID BY PURCHASER FOR THE PRODUCT WITHOUT INSTALLATION LABOR.

Some states do not allow limitations on how long an implied warranty lasts or the exclusion or limitation of incidental or consequential damage so the above limitations or exclusions may not apply to you. This Warranty gives you specific legal rights and you may also have other rights which vary from state to state.

VOXX
BY GENTEX CORPORATION

© 2026 VOXX by Gentex Corporation
2351 J. Lawson Blvd, Suite 110, Orlando, FL 32824



For Customer Service
Visit Our Website At
www.voxxelectronics.com
Product Information, Photos,
FAQ's, Owner's Manuals